

CoroMill® 300

Licht snijdende vlakfrezen en profielfrezen

Toepassing

- "Vol" frezen
- Vlakfrezen
- Infrezen
- Profielfrezen
- Uitsparingen frezen

ISO toepassingsgebied:



Voordelen en kenmerken

- Universeel product met een breed toepassingspectrum
- Groot assortiment, waardoor vele toepassingen worden afgedekt
- Frezen in een positieve uitvoering vertonen een licht snijdende werking en genereren lage snijkrachten, wat voor hoge productiviteit bij hoge snelheden een extra dichte vertanding mogelijk maakt met kleine wisselplaten, gecombineerd met hoge tafelhoedingen
- Vingerfrezen met superieure toegankelijkheid en snijwerking in alle voedingsrichtingen voor meerassige bewerkingen van complexe vormen



www.sandvik.coromant.com/coromill300

Koppelingen

- Coromant Capto®
- Doorn
- Cilindrische schacht
- Weldon
- Coromant EH
- Schroefdraadkoppelingen en hardmetaalsoorten voor alle materialen

Wisselplaten

- Wisselplaatgeometrieën en hardmetaalsoorten voor alle materialen

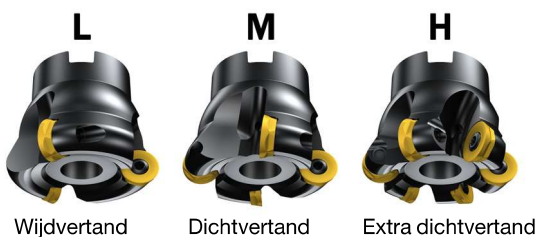
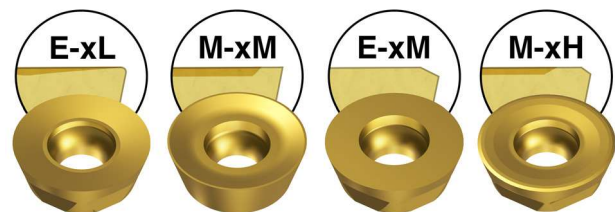

Wijdvertand

Dichtvertand

Extra dichtvertand

Een specifieke oplossing voor de instelling van wisselplaten met grootte 20 voorkomt beweging van de wisselplaat en maakt het mogelijk alle snijkanten te gebruiken.



I92



I99



N6

CoroMill® 300 vlakfrees

Coromant Capto® - inwendige koelmiddeltoevoer

Positieve uitvoering

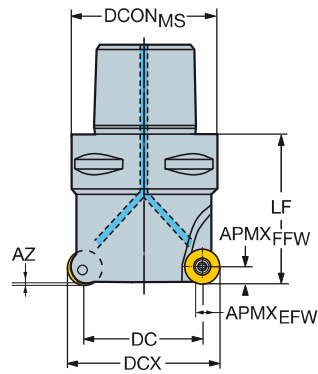
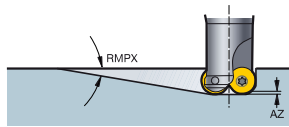

DC	CZC _{MS}	APMX _{EFW}	APMX _{FFW}	RMPX	AZ	CNSC	CNSC	Bestelnummer	Afmetingen, mm								
									DCON _{MS}	DCX	BD	LF	NM	KG	RPMX	CICT	MIID
23.0	12	C3	9.0	6.00	10°	3.0	3	R300-035C3-12M	32.0	35.0	28.3	43.0	3.0	0.36	32900	3	R300-1240..
	12	C3	9.0	6.00	10°	3.0	3	R300-035C3-12H	32.0	35.0	28.3	43.0	3.0	0.30	32900	4	R300-1240..
25.0	10	C3	7.5	5.00	7°	2.3	3	R300-035C3-10H	32.0	35.0	29.1	40.0	3.0	0.36	43200	4	R300-1032..
27.0	08	C3	6.0	4.00	4°	1.9	3	R300-035C3-08M	32.0	35.0	30.3	40.0	1.2	0.31	33800	4	R300-0828..
	08	C3	6.0	4.00	4°	1.9	3	R300-035C3-08H	32.0	35.0	30.3	40.0	1.2	0.31	33800	5	R300-0828..
30.0	12	C4	9.0	6.00	7°	3.0	3	R300-042C4-12M	40.0	42.0	35.3	50.0	3.0	0.60	28300	3	R300-1240..
	12	C4	9.0	6.00	7°	3.0	3	R300-042C4-12H	40.0	42.0	35.3	50.0	3.0	0.58	28300	4	R300-1240..
32.0	10	C4	7.5	5.00	5°	2.3	3	R300-042C4-10H	40.0	42.0	36.1	50.0	3.0	0.58	37200	5	R300-1032..
34.0	08	C4	6.0	4.00	3°	1.9	3	R300-042C4-08H	40.0	42.0	37.3	50.0	1.2	0.40	29800	6	R300-0828..
36.0	16	C5	12.0	8.00	7°	3.8	3	R300-052C5-16M	50.0	52.0	40.9	60.0	5.0	1.04	20600	4	R300-1648..
	16	C5	12.0	8.00	7°	3.8	3	R300-052C5-16H	50.0	52.0	40.9	60.0	5.0	1.04	20600	5	R300-1648..
40.0	12	C5	9.0	6.00	5°	3.0	3	R300-052C5-12M	50.0	52.0	45.3	50.0	3.0	0.98	24400	4	R300-1240..
	12	C5	9.0	6.00	5°	3.0	3	R300-052C5-12H	50.0	52.0	45.3	50.0	3.0	0.99	24000	5	R300-1240..
44.0	08	C5	6.0	4.00	2°	1.9	3	R300-052C5-08H	50.0	52.0	47.3	50.0	1.2	1.00	26100	8	R300-0828..
46.0	20	C6	15.0	10.00	9°	6.0	3	R300-066C6-20M	63.0	66.0		80.0	7.5	1.88	18478	4	R300-2060..
	20	C6	15.0	10.00	9°	6.0	3	R300-066C6-20H	63.0	66.0		80.0	7.5	1.83	18478	5	R300-2060..
50.0	16	C6	12.0	8.00	4°	3.8	3	R300-066C6-16M	63.0	66.0	54.9	60.0	5.0	1.77	17600	5	R300-1648..
	16	C6	12.0	8.00	4°	3.8	3	R300-066C6-16H	63.0	66.0	54.9	60.0	5.0	1.75	17600	6	R300-1648..
54.0	12	C6	9.0	6.00	3°	3.0	3	R300-066C6-12M	63.0	66.0	59.3	50.0	3.0	1.65	21700	5	R300-1240..
	12	C6	9.0	6.00	3°	3.0	3	R300-066C6-12H	63.0	66.0	59.3	50.0	3.0	1.67	21700	7	R300-1240..
58.0	08	C6	6.0	4.00	1°	1.9	3	R300-066C6-08H	63.0	66.0	61.3	50.0	1.2	1.65	23100	10	R300-0828..
60.0	20	C6	15.0	10.00	6°	6.0	3	R300-080C6-20M	63.0	80.0		80.0	7.5	2.24	15622	5	R300-2060..
	20	C6	15.0	10.00	6°	6.0	3	R300-080C6-20H	63.0	80.0		80.0	7.5	2.20	15622	6	R300-2060..
64.0	16	C6	12.0	8.00	3°	3.8	3	R300-080C6-16M	63.0	80.0	68.9	60.0	5.0	2.02	15400	5	R300-1648..
	16	C6	12.0	8.00	3°	3.8	3	R300-080C6-16H	63.0	80.0	68.9	60.0	5.0	2.02	15400	7	R300-1648..
68.0	12	C6	9.0	6.00	2°	3.0	3	R300-080C6-12M	63.0	80.0	73.3	50.0	3.0	1.82	18900	6	R300-1240..
	12	C6	9.0	6.00	2°	3.0	3	R300-080C6-12H	63.0	80.0	59.3	50.0	3.0	1.72	18900	8	R300-1240..
72.0	08	C6	6.0	4.00	1°	1.9	3	R300-080C6-08H	63.0	80.0	75.3	50.0	1.2	1.84	20500	12	R300-0828..
80.0	20	C8	15.0	10.00	4°	6.0	3	R300-100C8-20M	80.0	100.0		80.0	7.5	3.72	12843	6	R300-2060..
	20	C8	15.0	10.00	4°	6.0	3	R300-100C8-20H	80.0	100.0		80.0	7.5	3.48	12843	7	R300-2060..

Reserve onderdelen	
	Wisselplaat-schroef
08	5513 020-56
10	5513 020-09
12	5513 020-09
16	5513 020-50
20	5513 020-31

Ga voor de complete lijst van reserveonderdelen naar www.sandvik.coromant.com



I99



L2



N23



N6



N9



N15

CoroMill® 300 vlakfrees

Doornbevestiging - inwendige koelvoelstoftoevoer

Positieve uitvoering

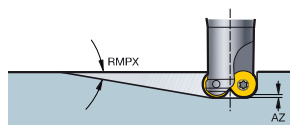

STDNO

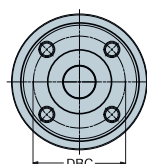

ISO6462

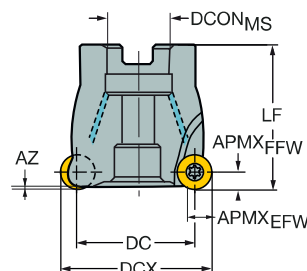

										Afmetingen, mm									
DC	CZC _{MS}	APMX _{EFW}	APMX _{FFW}	RMPX	AZ	CNSC	Bestelnummer		DCON _{MS}	ISO	DBC	DCX	LF	NM	KG	RPMX	CICT	MID	
32.0	08	16	6.0	4.00	3°	1.9	1	5	R300-040Q16-08M	16.0	A	40.0	40.0	1.2	0.44	30800	5	R300-0828..	
	08	16	6.0	4.00	3°	1.9	1	6	R300-040Q16-08H	16.0	A	40.0	40.0	1.2	0.20	30800	6	R300-0828..	
38.0	12	22	9.0	6.00	5°	3.0	1	4	R300-050Q22-12M	22.0	A	50.0	50.0	3.0	0.44	25000	4	R300-1240..	
	12	22	9.0	6.00	5°	3.0	1	5	R300-050Q22-12H	22.0	A	50.0	50.0	3.0	0.40	25000	5	R300-1240..	
40.0	12	22	9.0	6.00	5°	3.0	1	4	R300-052Q22-12M	22.0	A	52.0	50.0	3.0	0.79	24400	4	R300-1240..	
	12	22	9.0	6.00	5°	3.0	1	5	R300-052Q22-12H	22.0	A	52.0	50.0	3.0	0.46	24400	5	R300-1240..	
42.0	08	22	6.0	4.00	2°	1.9	1	8	R300-050Q22-08H	22.0	A	50.0	50.0	1.2	0.45	26700	8	R300-0828..	
44.0	08	22	6.0	4.00	2°	1.9	1	8	R300-052Q22-08H	22.0	A	52.0	50.0	1.2	0.85	26100	8	R300-0828..	
47.0	16	22	12.0	8.00	5°	3.8	1	4	R300-063Q22-16M	22.0	A	63.0	50.0	5.0	0.72	18200	4	R300-1648..	
	16	22	12.0	8.00	5°	3.8	1	6	R300-063Q22-16H	22.0	A	63.0	50.0	5.0	0.86	18200	6	R300-1648..	
51.0	12	22	9.0	6.00	3°	3.0	1	4	R300-063Q22-12L	22.0	A	63.0	50.0	3.0	0.97	22100	4	R300-1240..	
	12	22	9.0	6.00	3°	3.0	1	5	R300-063Q22-12M	22.0	A	63.0	50.0	3.0	0.80	22100	5	R300-1240..	
	12	22	9.0	6.00	3°	3.0	1	7	R300-063Q22-12H	22.0	A	63.0	50.0	3.0	0.57	22100	7	R300-1240..	
55.0	08	22	6.0	4.00	1°	1.9	1	10	R300-063Q22-08H	22.0	A	63.0	50.0	1.2	0.82	23700	10	R300-0828..	
60.0	20	27	15.0	10.00	6°	6.0	1	5	R300-080Q27-20M	27.0	A	80.0	50.0	7.5	0.95	15622	5	R300-2060..	
	20	27	15.0	10.00	6°	6.0	1	6	R300-080Q27-20H	27.0	A	80.0	50.0	7.5	1.07	15622	6	R300-2060..	
64.0	16	27	12.0	8.00	3°	3.8	1	5	R300-080Q27-16M	27.0	A	80.0	50.0	5.0	0.98	15400	5	R300-1648..	
	16	27	12.0	8.00	3°	3.8	1	7	R300-080Q27-16H	27.0	A	80.0	50.0	5.0	1.15	15400	7	R300-1648..	
68.0	12	27	9.0	6.00	2°	3.0	1	6	R300-080Q27-12M	27.0	A	80.0	50.0	3.0	0.90	18900	6	R300-1240..	
	12	27	9.0	6.00	2°	3.0	1	8	R300-080Q27-12H	27.0	A	80.0	50.0	3.0	1.06	18900	8	R300-1240..	
72.0	08	27	6.0	4.00	1°	1.9	1	12	R300-080Q27-08H	27.0	A	80.0	50.0	1.2	1.31	20500	12	R300-0828..	
80.0	20	32	15.0	10.00	4°	6.0	1	5	R300-100Q32-20L	32.0	A	100.0	63.0	7.5	2.46	12843	5	R300-2060..	
	20	32	15.0	10.00	4°	6.0	1	6	R300-100Q32-20M	32.0	A	100.0	63.0	7.5	2.40	12843	6	R300-2060..	
	20	32	15.0	10.00	4°	6.0	1	7	R300-100Q32-20H	32.0	A	100.0	63.0	7.5	2.41	12843	7	R300-2060..	
84.0	16	32	12.0	8.00	2°	3.8	1	6	R300-100Q32-16M	32.0	A	100.0	50.0	5.0	1.68	13300	6	R300-1648..	
	16	32	12.0	8.00	2°	3.8	1	8	R300-100Q32-16H	32.0	A	100.0	50.0	5.0	1.67	13300	8	R300-1648..	
105.0	20	40	15.0	10.00	3°	6.0	1	7	R300-125Q40-20M	40.0	B	125.0	63.0	7.5	3.03	10768	7	R300-2060..	
	20	40	15.0	10.00	3°	6.0	1	9	R300-125Q40-20H	40.0	B	125.0	63.0	7.5	2.93	10768	9	R300-2060..	
109.0	16	32	12.0	8.00	1°	3.8	1	8	R300-125Q32-16M	32.0	A	125.0	63.0	5.0	2.55	11900	8	R300-1648..	
	16	32	12.0	8.00	1°	3.8	1	10	R300-125Q32-16H	32.0	A	125.0	63.0	5.0	2.88	11900	10	R300-1648..	
140.0	20	40	15.0	10.00	2°	6.0	1	9	R300-160Q40-20M	40.0	B	160.0	63.0	7.5	4.93	9106	9	R300-2060..	
	20	40	15.0	10.00	2°	6.0	1	11	R300-160Q40-20H	40.0	B	160.0	63.0	7.5	4.83	9106	11	R300-2060..	
180.0	20	60	15.0	10.00	1°	6.0	0	11	R300-200Q60-20M	60.0	C	101.6	200.0	63.0	11.20	7799	11	R300-2060..	

	Reserve onderdelen
	Wisselplaat-schroef
08	5513 020-56
12	5513 020-09
16	5513 020-50
20	5513 020-31

Ga voor de complete lijst van reserveonderdelen naar www.sandvik.coromant.com



I99



L2



M1



N23



N6



N9



N15

CoroMill® 300 vlakfrees

Cilindrische schacht - interne koelmiddeltoevoer

Positieve uitvoering

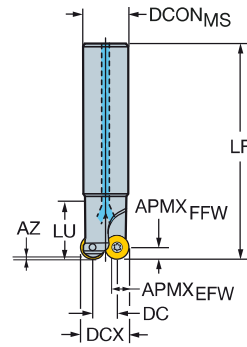
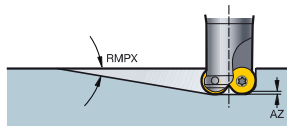

										Afmetingen, mm									
DC	CZC _{MS}	APMX _{EFW}	APMX _{FFW}	RMPX	AZ	CNSC	CNSC		Bestelnummer	DCON _{MS}	DCX	BD	LB	LF	(NM)	(KG)	RPMX	CICT	MIID
15.0	10	20	7.5	5.00	13°	2.3	1	2	R300-025A20-10M	20.0	25.0	19.1	33.0	150.0	3.0	0.50	2850	2	R300-1032..
17.0	08	20	6.0	4.00	8°	1.9	1	3	R300-025A20-08M	20.0	25.0	20.3	25.0	150.0	1.2	0.44	7200	3	R300-0828..
20.0	12	25	9.0	6.00	12°	3.0	1	2	R300-032A25-12M	25.0	32.0	25.3	25.0	190.0	3.0	0.82	8900	2	R300-1240..
	12	25	9.0	6.00	12°	3.0	1	3	R300-032A25-12H	25.0	32.0	25.3	25.0	150.0	3.0	0.65	3550	3	R300-1240..
22.0	10	25	7.5	5.00	7°	2.3	1	3	R300-032A25-10M	25.0	32.0	26.1	25.0	190.0	3.0	0.82	1470	3	R300-1032..
	10	25	7.5	5.00	7°	2.3	1	4	R300-032A25-10H	25.0	32.0	26.1	25.0	150.0	3.0	0.70	2850	4	R300-1032..
24.0	08	25	6.0	4.00	5°	1.9	1	4	R300-032A25-08M	25.0	32.0	27.3	25.0	190.0	1.2	0.79	9000	4	R300-0828..
	08	25	6.0	4.00	5°	1.9	1	5	R300-032A25-08H	25.0	32.0	27.3	25.0	150.0	1.2	0.61	3590	5	R300-0828..
28.0	12	32	9.0	6.00	8°	3.0	1	3	R300-040A32-12M	32.0	40.0	33.3	25.0	250.0	3.0	1.78	1140	3	R300-1240..
	12	32	9.0	6.00	8°	3.0	1	4	R300-040A32-12H	32.0	40.0	33.3	25.0	150.0	3.0	1.01	2850	4	R300-1240..

		Reserve onderdelen
DC		Wisselplaat-schroef
17.00-24.00	08	5513 020-56
15.00	10	5513 020-43
22.00	10	5513 020-09
20.00-28.00	12	5513 020-09

Ga voor de complete lijst van reserveonderdelen naar www.sandvik.coromant.com



I99



L2



N23



N6



N9







N15

CoroMill® 300 vlakfrees

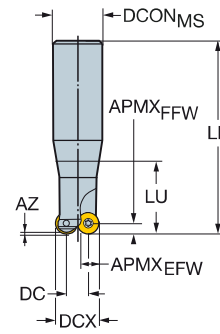
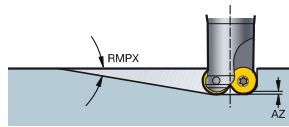
Cilindrische schacht

Neutraal model



										Afmetingen, mm											
DC		CZC _{MS}	APM _{EFW}	APM _{FFW}	RMPX	AZ		Bestelnummer		DCON _{MS}	DCX	BD	LB	LF	LU			RPMX	CICT	MIID	
5.0	05	16	3.8	2.50	20°	1.8	2	R300-010A16L-05L		16.0	10.0	9.1	18.0	160.0	25.4	0.6	0.32	15900	2	R300-0517..	
	07 20	16	5.3	3.50	20°	1.0	2	R300-012A16L-07L		16.0	12.0	10.4	21.0	200.0	37.8	0.9	0.38	8900	2	R300-0720..	
8.0	07 24	20	5.3	3.50	20°	0.9	2	R300-015A20L-07L		20.0	15.0	13.4	25.0	200.0	43.8	0.9	0.54	12700	2	R300-0724..	
	08	20	6.0	4.00	20°	1.8	2	R300-016A20L-08L		20.0	16.0	14.1	25.0	200.0	51.9	1.2	0.54	12700	2	R300-0828..	
10.0	10	25	7.5	5.00	20°	3.4	2	R300-020A25L-10L		25.0	20.0	18.1	30.0	250.0	48.8	3.0	0.87	8100	2	R300-1032..	
12.0	12	25	9.0	6.00	20°	2.7	2	R300-024A25L-12L		25.0	24.0	22.1	30.0	250.0	76.0	3.0	1.20	8900	2	R300-1240..	
13.0	12	32	9.0	6.00	20°	1.4	2	R300-025A32L-12L		32.0	25.0	23.1	30.0	250.0	42.9	3.0	1.69	15800	2	R300-1240..	
16.0	16	32	12.0	8.00	20°	4.8	2	R300-032A32L-16L		32.0	32.0	29.0	40.0	250.0	72.2	5.0	1.76	8700	2	R300-1648..	

		Reserve onderdelen
DC		Wisselplaat-schroef
5.00	05	5513 020-40
5.00	07 20	5513 020-41
8.00	07 24	5513 020-42
8.00	08	5513 020-36
10.00	10	5513 020-43
12.00-13.00	12	5513 020-39
16.00	16	5513 020-50

Ga voor de complete lijst van reserveonderdelen naar www.sandvik.coromant.com



199



L2



N23



N6



N9

CoroMill® 300 vlakfrees

Weldon

Neutraal model

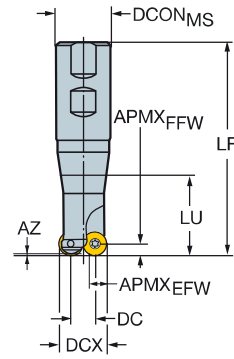
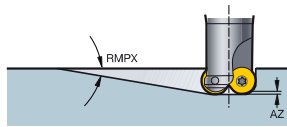

										Afmetingen, mm										
DC	CZC _{MS}	APMX _{EFW}	APMX _{FFW}	RMPX	AZ		Bestelnummer	DCON _{MS}	ISO	DCX	BD	LB	LF	LU	NM	KG	RPMX	CICT	MIID	
5,0	07 20	16	5,3	3,50	20°	1,0	2	R300-012B16L-07L	16,0	WE	12,0	10,4	21,0	109,0	37,6	0,9	0,24	34000	2	R300-0720..
8,0	07 24	20	5,3	3,50	20°	0,9	2	R300-015B20L-07L	20,0	WE	15,0	13,4	25,0	131,0	43,6	0,9	0,38	25000	2	R300-0724..
	08	20	6,0	4,00	20°	1,8	2	R300-016B20L-08L	20,0	WE	16,0	14,1	25,0	131,0	51,6	1,2	0,38	24700	2	R300-0828..
10,0	10	25	7,5	5,00	20°	3,4	2	R300-020B25L-10L	25,0	WE	20,0	18,1	30,0	137,0	48,4	3,0	0,58	34000	2	R300-1032..
13,0	12	32	9,0	6,00	20°	1,4	2	R300-025B32L-12L	32,0	WE	25,0	23,1	30,0	141,0	42,8	3,0	0,82	20200	2	R300-1240..

		Reserve onderdelen
DC		Wisselplaat-schroef
5,00	07 20	5513 020-41
8,00	07 24	5513 020-42
8,00	08	5513 020-36
10,00	10	5513 020-43
13,00	12	5513 020-39

Ga voor de complete lijst van reserveonderdelen naar www.sandvik.coromant.com



CoroMill® 300 vlakrees

Coromant EH - interne koelmiddeltoevoer

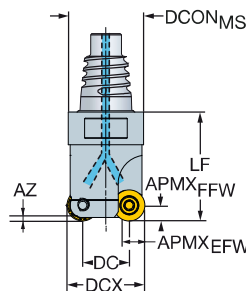
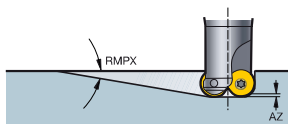

Neutraal model

										Afmetingen, mm										
DC	CZCMS	APMX _{EFW}	APMX _{FFW}	RMPX	AZ	CNSC		Bestelnummer		DCON _{MS}	DCX	BD	LB	LF	NM	KG	RPMX	CICT	MIID	
5.0	05	E10	3.8	2.50	20°	1.8	1	2	R300-10EH10-05L	9.7	10.0	9.0	13.1	20.0	0.6	0.06	20000	2	R300-0517..	
	07	20	E12	5.3	3.50	20°	1.0	1	2	R300-12EH12-07L	11.7	12.0	10.3	17.5	25.0	0.9	0.07	20000	2	R300-0720..
7.0	05	E12	3.8	2.50	10°	1.0	1	3	R300-12EH12-05M	11.7	12.0	11.0	12.5	20.0	0.6	0.10	20000	3	R300-0517..	
8.0	07	20	E12	5.3	3.50	20°	0.9	1	2	R300-15EH12-07M	11.7	15.0	13.3	17.5	25.0	0.9	0.10	20000	3	R300-0720..
	07	24	E12	5.3	3.50	20°	0.9	1	2	R300-15EH12-07L	11.7	15.0	13.3	17.5	25.0	0.9	0.10	20000	2	R300-0724..
	08	E16	6.0	4.00	20°	1.8	1	2	R300-16EH16-08L	15.5	16.0	14.0	21.3	30.0	1.2	0.09	20000	2	R300-0828..	
9.0	07	20	E16	5.3	3.50	15°	0.9	1	3	R300-16EH16-07M	15.5	16.0	14.3	16.3	25.0	0.9	0.11	20000	3	R300-0720..
10.0	10	E20	7.5	5.00	20°	3.4	1	2	R300-20EH20-10L	19.3	20.0	18.0	25.0	35.0	3.0	0.12	20000	2	R300-1032..	
12.0	08	E20	6.0	4.00	12°	1.5	1	3	R300-20EH20-08M	19.3	20.0	18.0	20.0	30.0	1.2	0.13	20000	3	R300-0828..	
	12	E20	9.0	6.00	20°	2.7	1	2	R300-24EH20-12L	19.3	24.0	22.0	25.0	35.0	3.0	0.17	15000	2	R300-1240..	
15.0	10	E25	7.5	5.00	15°	1.1	1	2	R300-25EH25-10L	24.2	25.0	23.0	24.5	35.0	3.0	0.20	15000	2	R300-1032..	
	10	E25	7.5	5.00	15°	1.3	1	3	R300-25EH25-10M	24.2	25.0	23.0	24.5	35.0	3.0	0.19	15000	3	R300-1032..	
16.0	16	E25	12.0	8.00	20°	4.8	1	2	R300-32EH25-16L	24.2	32.0	28.9	29.5	40.0	5.0	0.23	15000	2	R300-1648..	
20.0	12	E25	9.0	6.00	15°	1.4	1	3	R300-32EH25-12M	24.2	32.0	30.0	24.5	35.0	3.0	0.21	15000	3	R300-1240..	
22.0	10	E25	7.5	5.00	10°	1.7	1	4	R300-32EH25-10H	24.2	32.0	30.0	24.5	35.0	3.0	0.23	15000	4	R300-1032..	

Positieve uitvoering

										Afmetingen, mm									
DC	CZCMS	APMX _{EFW}	APMX _{FFW}	RMPX	AZ	CNSC		Bestelnummer		DCON _{MS}	DCX	BD	LB	LF	NM	KG	RPMX	CICT	MIID
17.0	08	E25	6.0	4.00	5°	0.6	1	3	R300-25EH25-08M	24.2	25.0	20.3	24.5	35.0	1.2	0.17	15000	3	R300-0828..
24.0	08	E25	6.0	4.00	5°	2.0	1	4	R300-32EH25-08M	24.2	32.0	27.3	24.5	35.0	1.2	0.21	15000	4	R300-0828..
	08	E25	6.0	4.00	5°	2.0	1	5	R300-32EH25-08H	24.2	32.0	27.3	24.5	35.0	1.2	0.20	15000	5	R300-0828..

Neutraal model

		Reserve onderdelen
DC		Wisselplaat-schroef
5.00-9.00	07 20	5513 020-41
8.00	07 24	5513 020-42
5.00-7.00	05	5513 020-40
8.00-12.00	08	5513 020-36
10.00-22.00	10	5513 020-43
12.00-20.00	12	5513 020-39
16.00	16	5513 020-50

Positieve uitvoering

Reserve onderdelen
Wisselplaat-schroef
5513 020-56

Ga voor de complete lijst van reserveonderdelen naar www.sandvik.coromant.com



CoroMill® 300 vlakrees

Schroefdraadkoppeling - interne koelmiddeltoevoer

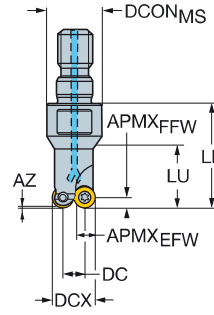
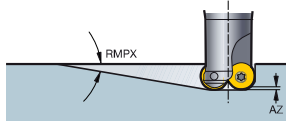

Neutraal model

										Afmetingen, mm										
DC	CZC _{MS}	APMX _{EFW}	APMX _{FFW}	RMPX	AZ	CNSC	Bestelnummer	DCON _{MS}	DCX	BD	LB	LF	LU	(NM)	(KG)	RPMX	CICT	MIID		
5,0	07 20	M8	5,3	3,50	20°	1,0	0	2	R300-12T08-07L	12,8	12,0	10,4	21,0	25,0	17,3	0,9	0,09	9100	2	R300-0720..
7,0	05	M8	3,8	2,50	10°	1,0	0	3	R300-12T08-05M	12,8	12,0	11,1	18,0	25,0		0,6	0,05	9100	3	R300-0517..
8,0	07 24	M8	5,3	3,50	20°	0,9	0	2	R300-15T08-07L	12,8	15,0	13,4		25,0		0,9	0,10	9100	2	R300-0724..
	08	M8	6,0	4,00	20°	1,8	0	2	R300-16T08-08L	12,8	16,0	14,0		25,0		1,2	0,05	9100	2	R300-0828..
10,0	10	M10	7,5	5,00	20°	3,4	1	2	R300-20T10-10L	17,8	20,0	18,1		30,0		3,0	0,09	9100	2	R300-1032..
12,0	08	M10	6,0	4,00	12°	1,5	1	3	R300-20T10-08M	17,8	20,0	18,1		30,0		1,2	0,03	9100	3	R300-0828..
	12	M12	9,0	6,00	20°	2,7	1	2	R300-24T12-12L	20,8	24,0	22,1		35,0		3,0	0,18	9100	2	R300-1240..
15,0	10	M12	7,5	5,00	15°	1,1	1	2	R300-25T12-10L	20,8	25,0	23,1		35,0		3,0	0,16	9100	2	R300-1032..
	10	M12	7,5	5,00	15°	1,3	1	3	R300-25T12-10M	20,8	25,0	23,1		35,0		3,0	0,20	9100	3	R300-1032..
20,0	12	M16	9,0	6,00	15°	1,4	1	3	R300-32T16-12M	28,8	32,0	30,1		45,0		3,0	0,31	9100	3	R300-1240..
22,0	10	M16	7,5	5,00	10°	1,7	1	4	R300-32T16-10H	28,8	32,0	30,1		45,0		3,0	0,33	9100	4	R300-1032..
23,0	12	M16	9,0	6,00	16°	5,0	1	3	R300-35T16-12M	28,8	35,0	33,1		45,0		3,0	0,34	9100	3	R300-1240..
25,0	10	M16	7,5	5,00	10°	3,6	1	4	R300-35T16-10H	28,8	35,0	33,1		45,0		3,0	0,38	9100	4	R300-1032..
28,0	12	M16	9,0	6,00	13°	5,0	1	4	R300-40T16-12M	28,8	40,0	38,1		45,0		3,0	0,35	9100	4	R300-1240..
30,0	10	M16	7,5	5,00	8°	3,6	1	5	R300-40T16-10H	28,8	40,0	38,1		45,0		3,0	0,37	9100	5	R300-1032..
	12	M16	9,0	6,00	12°	5,0	1	4	R300-42T16-12M	28,8	42,0	40,1		45,0		3,0	0,04	9100	4	R300-1240..
32,0	10	M16	7,5	5,00	7°	3,6	1	5	R300-42T16-10H	28,8	42,0	40,1		45,0		3,0	0,41	9100	5	R300-1032..

Positieve uitvoering

										Afmetingen, mm										
DC	CZC _{MS}	APMX _{EFW}	APMX _{FFW}	RMPX	AZ	CNSC	Bestelnummer	DCON _{MS}	DCX	BD	LB	LF	LU	(NM)	(KG)	RPMX	CICT	MIID		
17,0	08	M12	6,0	4,00	8°	1,9	1	3	R300-25T12-08M	20,8	25,0	20,3	18,0	35,0		1,2	0,18	9100	3	R300-0828..
24,0	08	M16	6,0	4,00	5°	1,9	1	4	R300-32T16-08M	28,8	32,0	27,3	28,0	45,0		1,2	0,30	9100	4	R300-0828..
	08	M16	6,0	4,00	5°	1,9	1	5	R300-32T16-08H	28,8	32,0	27,3	28,0	45,0		1,2	0,30	9100	5	R300-0828..
32,0	08	M16	6,0	4,00	3°	1,9	1	6	R300-40T16-08H	28,8	40,0	35,3	28,0	45,0		1,2	0,38	9100	6	R300-0828..

Neutraal model

		Reserve onderdelen
DC		Wisselplaat-schroef
5,00	07 20	5513 020-41
8,00	07 24	5513 020-42
7,00	05	5513 020-40
8,00-12,00	08	5513 020-36
10,00-32,00	10	5513 020-43
12,00-30,00	12	5513 020-39

Positieve uitvoering

Reserve onderdelen
Wisselplaat-schroef
5513 020-56

Ga voor de complete lijst van reserveonderdelen naar www.sandvik.coromant.com



CoroMill® 300 freeswisselplaat

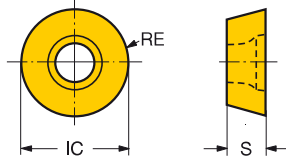
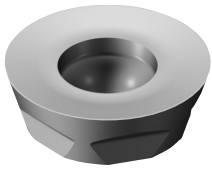

	RE	Bestelnummer	Afmetingen, mm																						
			P			M			K		N		S		H										
			1130	4220	4330	4340	1040	1130	2040	1020	3040	3330	H13A	1130	H13A	1130	H13A	S9T	S4T	1010	1130	IC	S		
Licht	08	4,00 R300-0828E-KL												*									8,0	2,78	
		4,00 R300-0828E-PL	*				*							*		*	*	*	*	*	*	*	*	8,0	2,78
	10	5,00 R300-1032E-KL												*										10,0	3,18
		5,00 R300-1032E-PL	*				*							*		*	*	*	*	*	*	*	*	10,0	3,18
	12	6,00 R300-1240E-ML					*	*																12,0	3,97
		6,00 R300-1240E-PL	*			*	*	*						*		*	*	*	*	*	*	*	*	12,0	3,97
	16	8,00 R300-1648E-ML					*	*																16,0	4,76
		8,00 R300-1648E-PL	*			*	*	*						*		*	*	*	*	*	*	*	*	16,0	4,76
	20	10,00 R300-2060E-ML					*	*																20,0	6,48
		10,00 R300-2060E-PL	*			*	*	*						*		*	*	*	*	*	*	*	*	20,0	6,48
Middelmatig	05	2,50 R300-0517E-PM	*		*								*		*	*	*	*	*	*	*	*	5,0	1,70	
		07 20 3,50 R300-0720E-MM					*						*		*	*	*	*	*	*	*	*	7,0	1,99	
	07 20 3,50 R300-0720E-PM	*		*								*		*	*	*	*	*	*	*	*	*	7,0	1,99	
	07 24	3,50 R300-0724E-MM					*						*		*	*	*	*	*	*	*	*	7,0	2,38	
		3,50 R300-0724E-PM	*		*								*		*	*	*	*	*	*	*	*	*	7,0	2,38
	08	4,00 R300-0828E-KM							*															8,0	2,78
		4,00 R300-0828E-MM					*	*						*		*	*	*	*	*	*	*	*	8,0	2,78
	08	4,00 R300-0828E-PM	*		*		*	*					*		*	*	*	*	*	*	*	*	*	8,0	2,78
		4,00 R300-0828M-MM					*	*					*		*	*	*	*	*	*	*	*	*	8,0	2,78
	08	4,00 R300-0828M-PM	*		*		*	*					*		*	*	*	*	*	*	*	*	*	8,0	2,78
4,00 R300-0828M-PM		*		*		*	*					*		*	*	*	*	*	*	*	*	*	8,0	2,78	
10	5,00 R300-1032E-MM					*	*						*		*	*	*	*	*	*	*	*	10,0	3,18	
	5,00 R300-1032E-PM	*		*		*	*					*		*	*	*	*	*	*	*	*	*	10,0	3,18	
10	5,00 R300-1032M-MM					*	*						*		*	*	*	*	*	*	*	*	10,0	3,18	
	5,00 R300-1032M-PM	*		*		*	*					*		*	*	*	*	*	*	*	*	*	10,0	3,18	
12	6,00 R300-1240E-KM							*	*			*		*	*	*	*	*	*	*	*	*	12,0	3,97	
	6,00 R300-1240E-MM					*	*						*		*	*	*	*	*	*	*	*	12,0	3,97	
12	6,00 R300-1240E-PM	*		*		*	*					*		*	*	*	*	*	*	*	*	*	12,0	3,97	
	6,00 R300-1240M-MM					*	*						*		*	*	*	*	*	*	*	*	12,0	3,97	
12	6,00 R300-1240M-PM	*		*		*	*					*		*	*	*	*	*	*	*	*	*	12,0	3,97	
	6,00 R300-1240M-PM	*		*		*	*					*		*	*	*	*	*	*	*	*	*	12,0	3,97	
16	8,00 R300-1648E-MM					*	*						*		*	*	*	*	*	*	*	*	16,0	4,76	
	8,00 R300-1648E-PM	*		*		*	*					*		*	*	*	*	*	*	*	*	*	16,0	4,76	
16	8,00 R300-1648M-MM					*	*						*		*	*	*	*	*	*	*	*	16,0	4,76	
	8,00 R300-1648M-PM	*		*		*	*					*		*	*	*	*	*	*	*	*	*	16,0	4,76	
20	10,00 R300-2060E-MM					*	*						*		*	*	*	*	*	*	*	*	20,0	6,48	
	10,00 R300-2060E-PM	*		*		*	*					*		*	*	*	*	*	*	*	*	*	20,0	6,48	
20	10,00 R300-2060M-MM					*	*						*		*	*	*	*	*	*	*	*	20,0	6,48	
	10,00 R300-2060M-PM	*		*		*	*					*		*	*	*	*	*	*	*	*	*	20,0	6,48	
Zwaar	08	4,00 R300-0828M-KH							*	*			*		*	*	*	*	*	*	*	*	8,0	2,78	
		4,00 R300-0828M-MH					*	*					*		*	*	*	*	*	*	*	*	8,0	2,78	
	10	5,00 R300-1032M-KH							*	*			*		*	*	*	*	*	*	*	*	10,0	3,18	
		5,00 R300-1032M-MH					*	*					*		*	*	*	*	*	*	*	*	*	10,0	3,18
	12	6,00 R300-1240M-KH					*	*	*	*			*		*	*	*	*	*	*	*	*	*	12,0	3,97
		6,00 R300-1240M-MH					*	*	*	*			*		*	*	*	*	*	*	*	*	*	12,0	3,97
	16	8,00 R300-1648M-KH					*	*	*	*			*		*	*	*	*	*	*	*	*	*	16,0	4,76
		8,00 R300-1648M-MH					*	*	*	*			*		*	*	*	*	*	*	*	*	*	16,0	4,76
	20	10,00 R300-2060M-KH					*	*	*	*			*		*	*	*	*	*	*	*	*	*	20,0	6,48
		10,00 R300-2060M-MH					*	*	*	*			*		*	*	*	*	*	*	*	*	*	20,0	6,48
20	10,00 R300-2060M-PH	*		*		*	*				*		*	*	*	*	*	*	*	*	*	*	20,0	6,48	



192

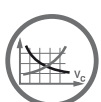

I154



I175



N23



N10

